

An Accurate Modeling of Different Types of Photovoltaic Modules Using Experimental Data

Vanjari Venkata Ramana*[‡], Debashisha Jena*, D. N. Gaonkar*

*Department of Electrical and Electronics Engineering, National Institute of Technology Karnataka,

Surathkal, Mangalore, India. Pin:575025

(venkat.vr90@gmail.com; bapu4002@gmail.com; dngaonkar@gmail.com)

[‡] Corresponding Author; Vanjari Venkata Ramana, Tel-91-9632238998

e-mail: venkat.vr90@gmail.com

Received: 04.04.2016 Accepted:01.06.2016

Abstract- In this paper an approach to model different types of PV modules using single diode model is presented. The proposed method utilizes the characteristics of diode ideality factor, shunt resistance and series resistance independently for developing accurate solar PV model. Apart from this, the proposed model utilizes experimental values obtained from the solar array simulator for implementing the proposed approach. The procedure mainly focuses on developing an accurate method for thin film solar modules using a simplified approach. The model is implemented in MATLAB and is validated with existing model and experimental values obtained from solar array simulator.

Keywords PV modeling, thin film modules, single diode model, Solar array simulator

1. Introduction

Photovoltaic (PV) models are being developed in order to predict the performance of PV sources in different operating conditions. There are many models in the literature. Among them, single diode model and two diode model are widely adopted [1]. Commercially three types of PV modules are widely used. They are mono-crystalline silicon modules, polycrystalline silicon modules and thin film modules. The accuracy among the three types varies in a decreasing order from former to latter [2].

There are many methods presented in the literature for modelling PV systems. A comprehensive review of all modelling techniques is presented in [3]. Most of the models presented in the literature are aimed at modelling mono-crystalline and poly-crystalline PV modules using different techniques.

For instance, the models proposed in [2], presents a power matching algorithm for a single diode model by varying the value of series resistance and parallel resistance simultaneously for accurately fitting the characteristic curve at standard test conditions. The diode ideality factor is arbitrarily chosen. This concept is extended to two-diode model in [4]. There are many other models presented in the literature that use conventional methods based on datasheet

parameters for modelling PV modules. All these models predict the characteristics accurately for mono-crystalline and poly-crystalline modules. However, they fail to accurately predict the characteristics of thin film solar cells.

There are other methods presented in literature which are based on optimization techniques and soft computing techniques. Even though these methods envisage the behavior of PV modules accurately, they are highly complex. The authors in [5] presented an approach of modelling PV modules for amorphous silicon solar cells. In this an improved single diode model with two additional parameters are used, thereby increasing the number of computational parameters to seven.

This paper mainly focuses on developing an accurate model for different types of solar modules. Mainly the proposed model is developed to increase the accuracy of thin film modules. The proposed model utilizes the experimental values and the effect of equivalent circuit parameters viz., diode ideality factor, series resistance and parallel resistance on characteristic curve. The model is implemented in MATLAB and is verified using the experimental results taken from solar array simulator and verified with one of the existing model in the literature.

The paper is organized as follows: section 2 explains about the PV modelling procedure, section 3 presents the results and discussions. Conclusions are drawn in section 4.

2. PV Modelling

The most widely adopted single diode model is used to model solar PV module. It is presented in fig.1. The parameters to be computed are photovoltaic current (I_{ph}), reverse saturation current of diode D (I_o), series resistance (R_s), parallel resistance (R_p) and ideality factor of diode D (a).

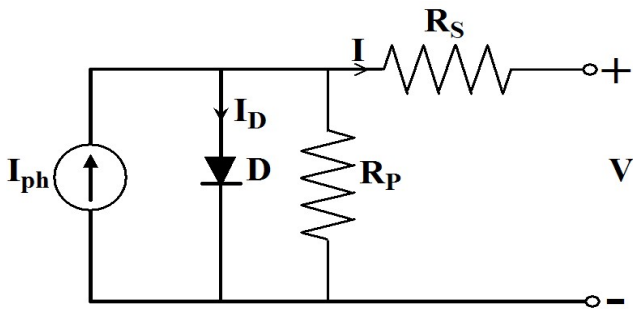

Fig. 1.Single Diode Model

Applying KCL to fig.1, eq. (1) is obtained.

$$I = I_{ph} - I_o \left[\exp \left(\frac{q(V + IR_s)}{akTN_s} \right) - 1 \right] - \frac{V + IR_s}{R_p} \tag{1}$$

Substituting $V=0$ in eq. (1), open circuit condition is obtained and is presented in eq. (2).

$$0 = I_{ph} - I_o \left\{ \exp \left(\frac{qV_{oc}}{akTN_s} \right) - 1 \right\} - \frac{V_{oc}}{R_p} \tag{2}$$

Similarly substituting $I=0$ in equation (1), short circuit condition is obtained and is present in eq. 3 [6].

$$I_{sc} = I_{ph} - I_o \left\{ \exp \left(\frac{qI_{sc}R_s}{akTN_s} \right) - 1 \right\} - \frac{I_{sc}R_s}{R_p} \tag{3}$$

where V is the output voltage of PV module, I is the output current of PV module, V_{oc} is open circuit voltage, I_{sc} is short circuit current, q is electron charge, k is Boltzmann constant, N_s is number of cells connected in series in a module and T is module temperature.

Since the proposed approach is based on variation of the three equivalent circuit parameters (R_s , R_p and a) sequentially, the effects of these parameters on I - V characteristics are initially studied. Based on this, a procedure is developed to accurately predict the output characteristics of PV module.

2.1 Effect of Variation of Parameters on I-V Curve

The effect of variation of R_s when other equivalent circuit parameters are held constant is presented in fig. 2. The

fill factor of the predicted curve increases with decrease in value of R_s . Moreover, the value of R_s significantly affects the region between open circuit point and maximum power point (voltage source region) and it is termed as region R1.

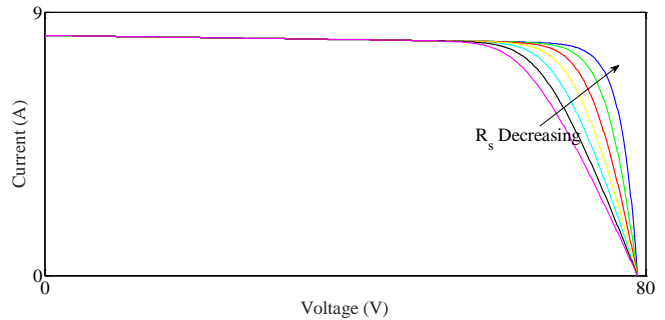

Fig. 2.Effect of R_s variation on I - V curve

When parallel resistance is varied maintaining other parameters constant, variation is more in the region between short circuit point and maximum power point (current source region). This region is termed as R2. The fill factor of the predicted curve increases with decrease in value of R_p . It can be observed from fig. 3.

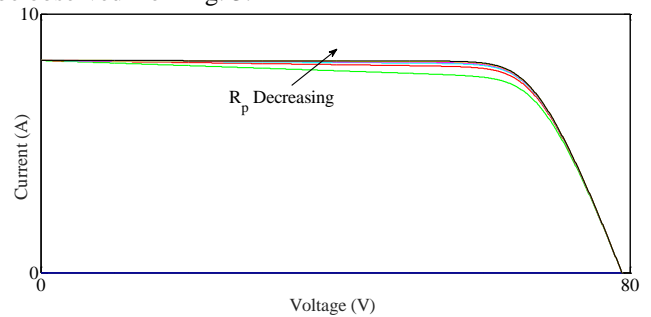

Fig. 3.Effect of R_p variation on I - V curve

There is an increase in the value of fill factor with the increase in value of diode ideality factor. The variation of a when other parameters are maintained constant is presented in fig. 4. The sensitivity of characteristics with respect to diode ideality factor is more around the maximum power point and voltage source region. This region is termed as region R3.

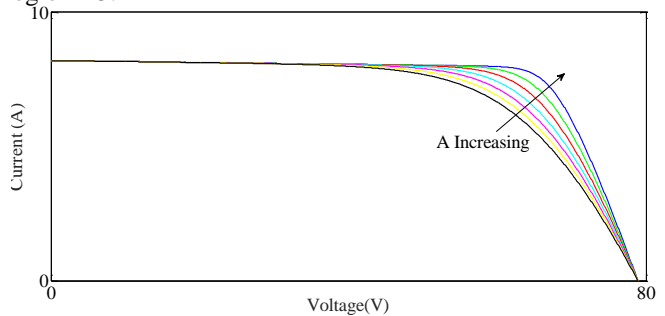

Fig. 4.Effect of a variation on I - V curve

2.2 Proposed Model

Initially the module parameters are initialized. These specifications are obtained from solar array simulator [7]. The experimental values of V and I that are used for

modelling solar module are taken from solar array simulator using rheostat as shown in fig. 5. Initial value of a is assumed unity. The initial value of parallel resistance is obtained using eq. (4) [2].

$$R_{pmin} = \frac{V_{mp}}{I_{scn} - I_{mp}} - \frac{V_{ocn} - V_{mp}}{I_{mp}} \quad (4)$$



Fig. 5. Solar array simulator with resistive load

The entire experimental data of the curve is divided into three regions: R1, R2, R3. R1 covers the region of the curve from maximum power point to open circuit point. This region is for calculating the value of R_s . R2 covers the region of the curve from short circuit point to maximum power point. This region is for calculating the value of R_p . R3 covers the region of the curve around MPP and region R1. This region is for calculating the value of a .

With the initial values of R_p and a and R_s is incremented first. The iterations are continued until error in region R1 is less than pre-specified tolerance limit. After the value of R_s is obtained the value, R_p is calculated in similar manner. Then the values of a and R_s are varied simultaneously until the error in the region R3 is less than pre-specified tolerance limit. Once the best fit is obtained with the values of a , R_s and R_p , the values of I_{ph} and I_o are calculated using eq. (2) and eq. (3). The flowchart of the proposed model is presented in fig. 6.

3. Results and Discussions

The proposed model is verified with the experimental results obtained from solar array simulator. Two modules are considered for validating the proposed model: Solarax and Sanyo. Solarax is thin film solar module and Sanyo is the mono-crystalline model. The specifications of PV module are taken from solar array simulator using a rheostat load and are presented in table I.

Table I
 Module Parameters

Parameters	Solarax_41W	Sanyo_214W
I_{sc} (A)	3.363	4.39
V_{oc} (V)	21.11	62.9
I_{mp} (A)	2.6778	4.029
V_{mp} (V)	15.288	52.9
P_{mp} (W)	40.93	213.13

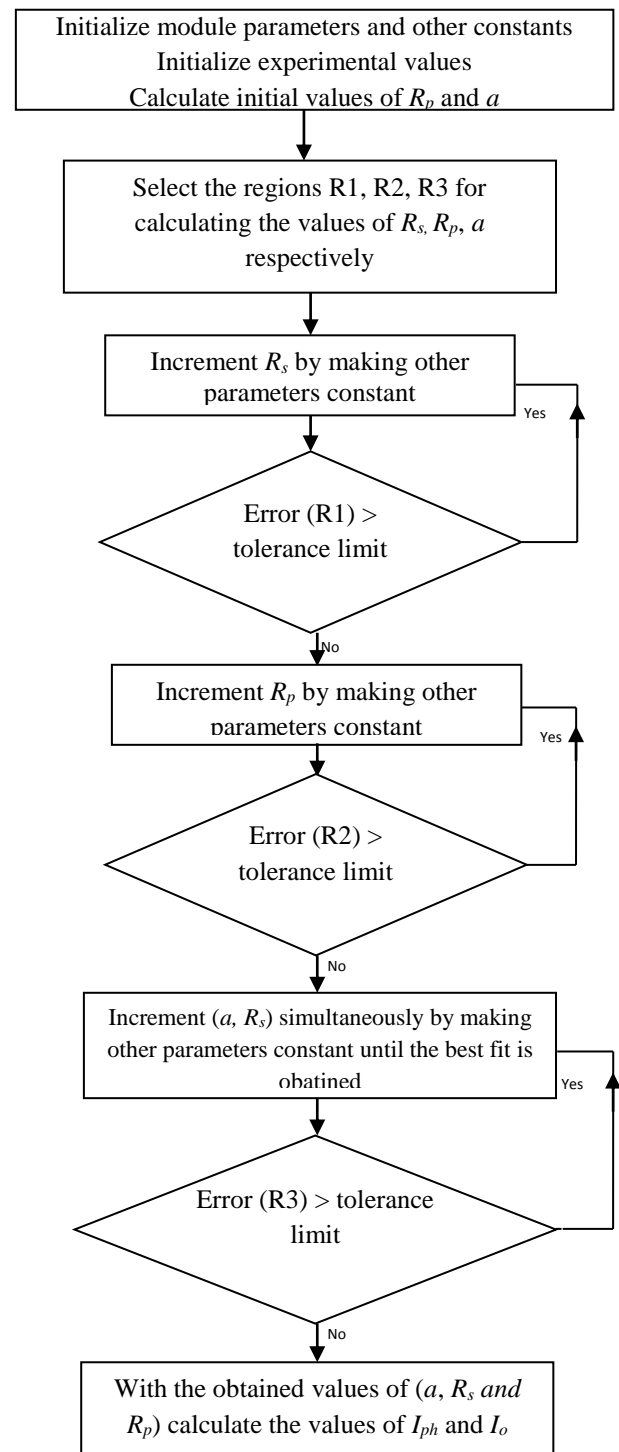

Fig. 6. Flowchart of the proposed Model

3.1 Case 1: Validation of Thin film module (Solarax)

A comparison is made between proposed model and existing model [2]. The equivalent circuit parameters calculated from the proposed and existing model [2] are presented in table II.

Table II
 Equivalent Circuit Parameters of Solarax Module

Parameters	Existing Model [2]	Proposed Model
I_{ph} (A)	3.5087	3.377
I_o (A)	3.3472×10^{-10}	9.5×10^{-4}
R_s (Ω)	1.18	0.491
R_p (Ω)	27.22	125.437
a	1	2.81

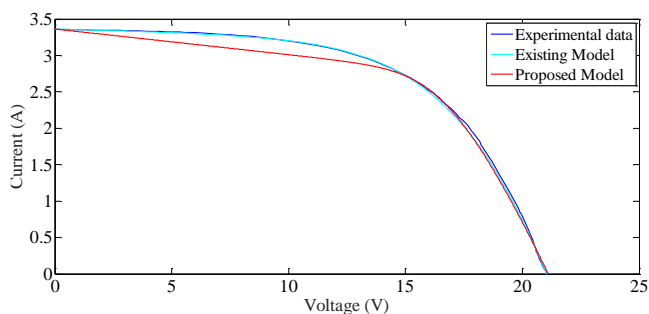

Fig. 7. I-V Curve of Solarax Module

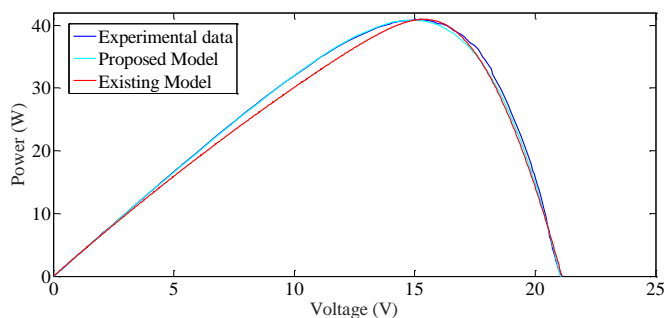

Fig. 8. P-V Curve of Solarax Module

Fig. 7 compares the I - V characteristics of proposed model with existing model [2] and the experimental values. Although the results obtained from the proposed model and existing model are closely matching the experimental results in voltage source region, the proposed model outperforms the existing model in current source region. This is also evident from the P - V curves presented in fig. 8.

Absolute error is the difference between measured value and simulated value. Absolute errors of both the models are presented in fig. 9. It is evident that the proposed model is providing better result in many cases. The accuracy of [2] is more at V_{mp} because the power matching algorithm used in [2] checks the condition at maximum power. For rest of the region, the accuracy of [2] is less.

3.2 Case 2: Validation of mono-crystalline module (Sanyo)

The module presented in [2] works accurately for mono-crystalline and poly-crystalline modules. But for some of these modules the methods diverge. Table III shows the equivalent circuit parameters of Sanyo PV module. In this the module diverges upon reaching the $R_s=0.005 \Omega$. But the proposed model accurately finds the characteristics for this module.

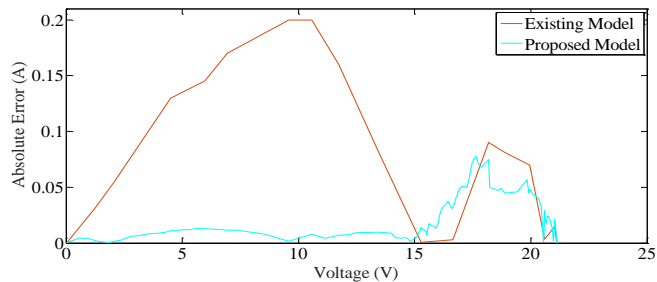

Fig. 9. Absolute Error of Solarax Module

Table III
 Equivalent Circuit Parameters of Sanyo Module

Parameters	Existing Model [2]	Proposed Model
I_{ph} (A)	4.39006	4.3918
I_o (A)	1.252×10^{-7}	1.266×10^{-7}
R_s (Ω)	0.005	0.467
R_p (Ω)	620.991	1088.95
a	1.12	1.12

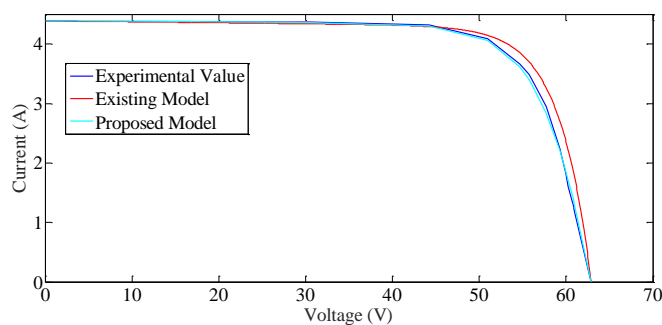

Fig. 10. I-V curve of Sanyo Module

Fig. 10 shows the I - V characteristics of Sanyo PV module. It is evident that the proposed model matches accurately with the experimental data compared to existing model [2]. Corresponding P - V characteristics are presented in fig. 11.

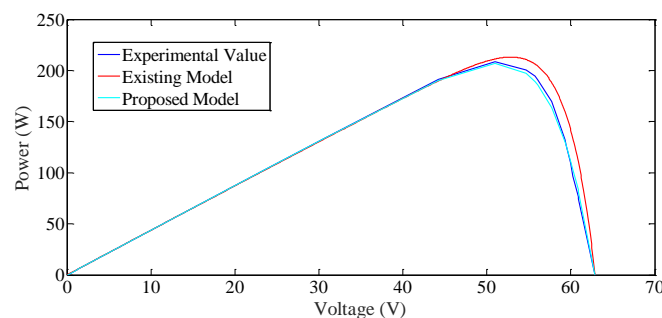

Fig. 11. P-V curve of Sanyo Model

The absolute errors of both the existing model and the proposed model are presented in fig. 12. Since the value of R_s is very less a huge error is found in the region R1 of the existing model [2]. But the error is comparatively much less in the proposed model.

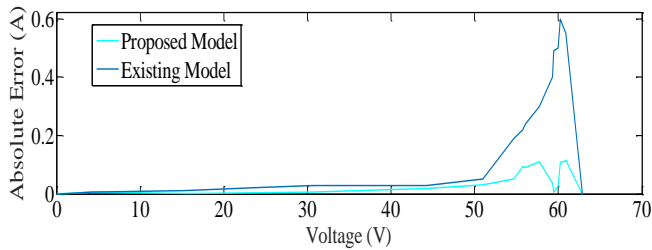

Fig. 12. Absolute Error of Sanyo Model

4. Conclusion

A method to model PV module of different kinds is presented using a single diode model. The proposed model used the characteristics of diode ideality factor, series resistance and parallel resistance to model PV module. Experimental values are used for modelling the proposed approach. The experimental values are divided into three regions based on the sensitivities of diode ideality factor, series resistance and parallel resistance on characteristic curves. An iterative process is followed by varying the value of the three parameters sequentially. The proposed model is validated with the existing model and the experimental data. Solar array simulator is used to get the experimental data. The proposed model is giving better results than existing model in most of the cases.

Acknowledgements

The authors would like to thank Central Power Research Institute, Bangalore for sponsoring the research work under Research Sponsored on Power (RSoP) scheme.

References

- [1] Hejri M., Mokhtari H., Azizian M. R., Ghandhari, M., and Soder, L., "On the parameter extraction of a five-parameter double-diode model of photovoltaic cells and modules", IEEE Journal of Photovoltaics, Vol.4, No. 3, pp. 915-923, 2014.
- [2] Gradella V. M., Gazoli J, R., and Filho E. R., "Comprehensive approach to modeling and simulation of photovoltaic arrays", IEEE Transactions on Power Electronics, Vol. 24, No. 5, pp. 1198-1208, 2009.
- [3] Jena D., and Ramana V. V., "Modeling of photovoltaic system for uniform and non-uniform irradiance: A critical review" Renewable and Sustainable Energy Reviews, Vol. 52, pp. 400-417, 2015.
- [4] Kashif I, Salam Z., and Taheri H., "Simple, fast and accurate two-diode model for photovoltaic modules" Solar Energy Materials and Solar Cells, Vol. 95, No. 2, pp. 586-594, 2011.
- [5] Simon L., Averbukh M., and Kuperman A. "Issues in modeling amorphous silicon photovoltaic modules by single-diode equivalent circuit" IEEE Transactions on Industrial Electronics, Vol. 61, No. 12, pp. 6785-6793, 2014.

- [6] Dezso S., Teodorescu R., and Rodriguez P, "PV panel model based on datasheet values" IEEE International Symposium on Industrial Electronics, Vigo, pp. 2392 – 2396, 2007.
- [7] Chroma Programmable Solar Array Simulator(62020H-150S) Manual.